

# AURORALIGHT

PROJECT: \_\_\_\_\_

SKU #: \_\_\_\_\_

TYPE: \_\_\_\_\_

## SONOMA

IGR035102

The Sonoma directional marker is a high flux; low wattage LED luminaire. Coupled with a brass body, our Thermally Integrated® LED Module provides superior heat dissipation, longer life, and higher performance.

- Thermally Integrated® w/ Copper Core Technology®
- Cree LED™ XLAMP® Extreme High Power (XHP)
- IC Rated for Interior, Exterior and Wet Location Use
- Ideal for driveways, wide pathways & walkways



### CONFIGURATOR:

IGR035102	LED	FINISH
	<input type="text"/>	<input type="text"/>
<b>( ) = Most common configuration</b>	<b>(2704) 2700K 4W</b> (3004) 3000K 4W	<b>(NAT) Natural Brass</b> (BLP) Bronze Living Patina (BLPX) Extra Dark BLP (NI) Nickel PVD

### AVAILABLE FINISHES:



FIXTURE DIMENSIONS	D3-5/8" x H1-7/8"
LIGHT SOURCE	Integrated LED
COLOR TEMPERATURES	2700K, 3000K
WATTAGES	4W
CRI (RA)	80 CRI
VOLTAGE	12V
DELIVERED LUMENS	34lm (3000K)
DIMMABLE	Yes, Dim to <10% via Transformer
DRIVER	Yes, 12V Integral Constant Current
TRANSFORMER	No, 12V AC/DC Transformer Required
MOUNT	Included Copper Can w/ Rear Entry
BEAM SPREAD	180°
FINISH	Included Natural Brass
MATERIAL	Brass & Copper
WIRE LENGTH	24"
LOCATION	Interior & Exterior Wet
CERTIFICATIONS	UL, IP66, IP67, IC, Drive Over

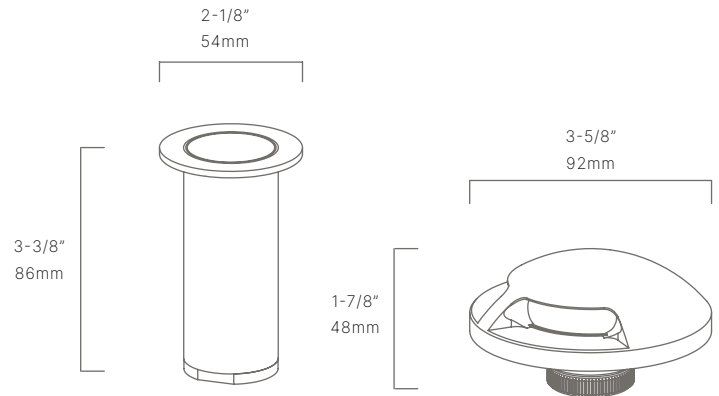

\*For complete warranty terms, please visit: [www.auroralight.com/warranty/](http://www.auroralight.com/warranty/)

P. 760.931.2910

O. 2742 Loker Ave. W Carlsbad CA 92010

W. [www.auroralight.com](http://www.auroralight.com)

MADE IN USA  
WITH DOMESTIC & IMPORTED MATERIALS



# AURORALIGHT

PROJECT: \_\_\_\_\_

SKU #: \_\_\_\_\_

TYPE: \_\_\_\_\_

## ADD-ONS

### MOUNTS

SCE008	Side Conduit Entry
MJB112402	Micro J-Box
MJB112503	Micro J-Box w/ Flush Mount

\*For complete details, please visit [auroralight.com/mounts/](http://auroralight.com/mounts/)

### MOUNTS

